

S1S 1117 Premier

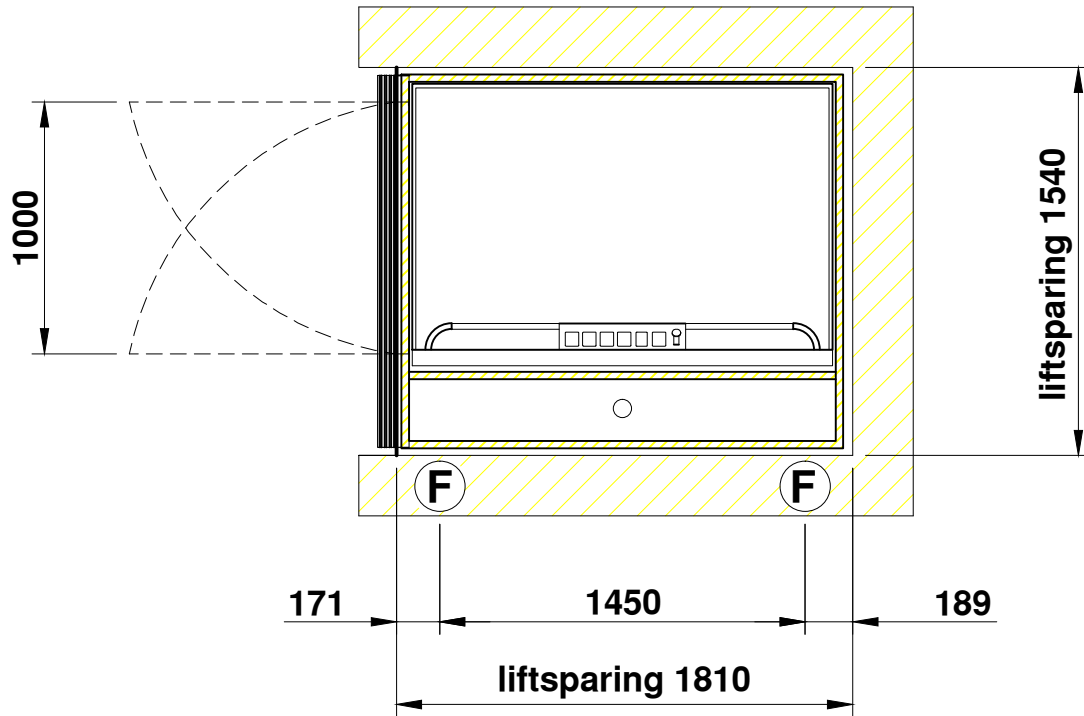

AFMETINGEN IN MM	PAS TOLERANTIES VOLGENS NEN 3311	AM. PROJ.		
ONDERWERP: Platformlift enkelzijdige toegang 1100 x 1700 630KG 8 personen				SCHAAL: 1:30
				GETEKEND: DATUM: 1-mei-2013
				REVISIE: -
				REVISIE: -
TEKENING NUMMER:			FORMAAT:	
Voorbeeld			A4	
 Vredeweg 7 - 1505 HH - Zaandam - telefoon 0342-426000 E-mail: info@axessliften.nl - Internet: www.axessliften.nl				

All rights strictly reserved. Reproductions or issue to third parties in any form whatever is not permitted without written authority from the proprietor.