

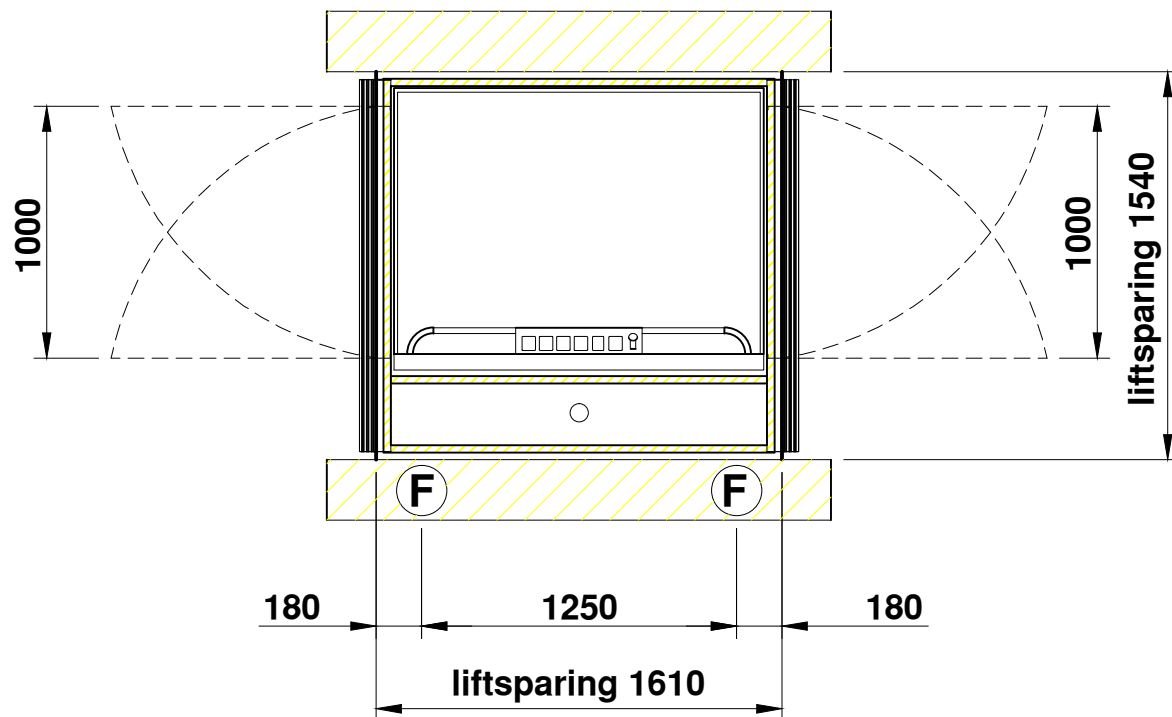

S2O 1115 Premier



AFMETINGEN IN MM	PAS TOLERANTIES VOLGENS NEN 3311	AM. PROJ. 	
ONDERWERP: Platformlift overliggende toegang 1100 x 1500 400KG/630KG 5 personen/8 personen		SCHAAL: 1:30	GETEKEND: DATUM: 1-mei-2013
 Vredeweg 7 - 1505 HH - Zaandam - telefoon 0342-426000 E-mail: info@axessliften.nl - Internet: www.axessliften.nl		REVISIE: -	
		REVISIE: -	
		TEKENING NUMMER:	FORMAAT:
		Voorbeeld	A4
All rights strictly reserved. Reproductions or issue to third parties in any form whatever is not permitted without written authority from the proprietor.			